

Errata for **Dazzling New York Beauty Sampler #11402**

Page 68,

Pattern J 5" - 7" is missing. It is on Pullout page P1.

Page 79 and Pullout page P5,

The callouts in Crocodile 7"-8" Unit E are incorrect.

Page 83,

Pattern Peacock Subunit is missing. It is on Pullout page P2.

Page 85 and Pullout page P3,

the callouts in the Jellyfish Subunit B are incorrect.

O:5 should be O:1

O:2 should be O:4

A:1 should be A:5

A:4 should be A:2

Page 100,

Pattern Lyrebird 3" – 5" Unit B is missing. It is on Pullout page 4.

Page 104 and Pullout page P2,

Pattern Sheathtail Bat Subunit A is backwards.

Attached is a PDF that includes this pattern.

Visit us at ctpub.com

Page 185, 186, 187, and Pullout page P6,

The title of these patterns should be Bluebottle 9 1/4" - 14 1/2" Unit D.

Pages 208, 209, and Pullout page P3,

The title of this pattern should be Fruit Bat 5" - 9 1/4" Unit C.

The corrected pages are attached.

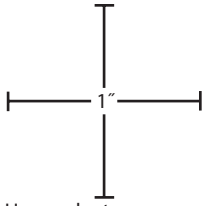

Use a ruler to measure these inch marks to verify that printout is correctly sized.

Pattern J
5" - 7"

Pattern K
7" - 8"

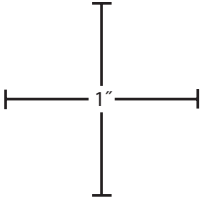

Use a ruler to measure these inch marks to verify that printout is correctly sized.

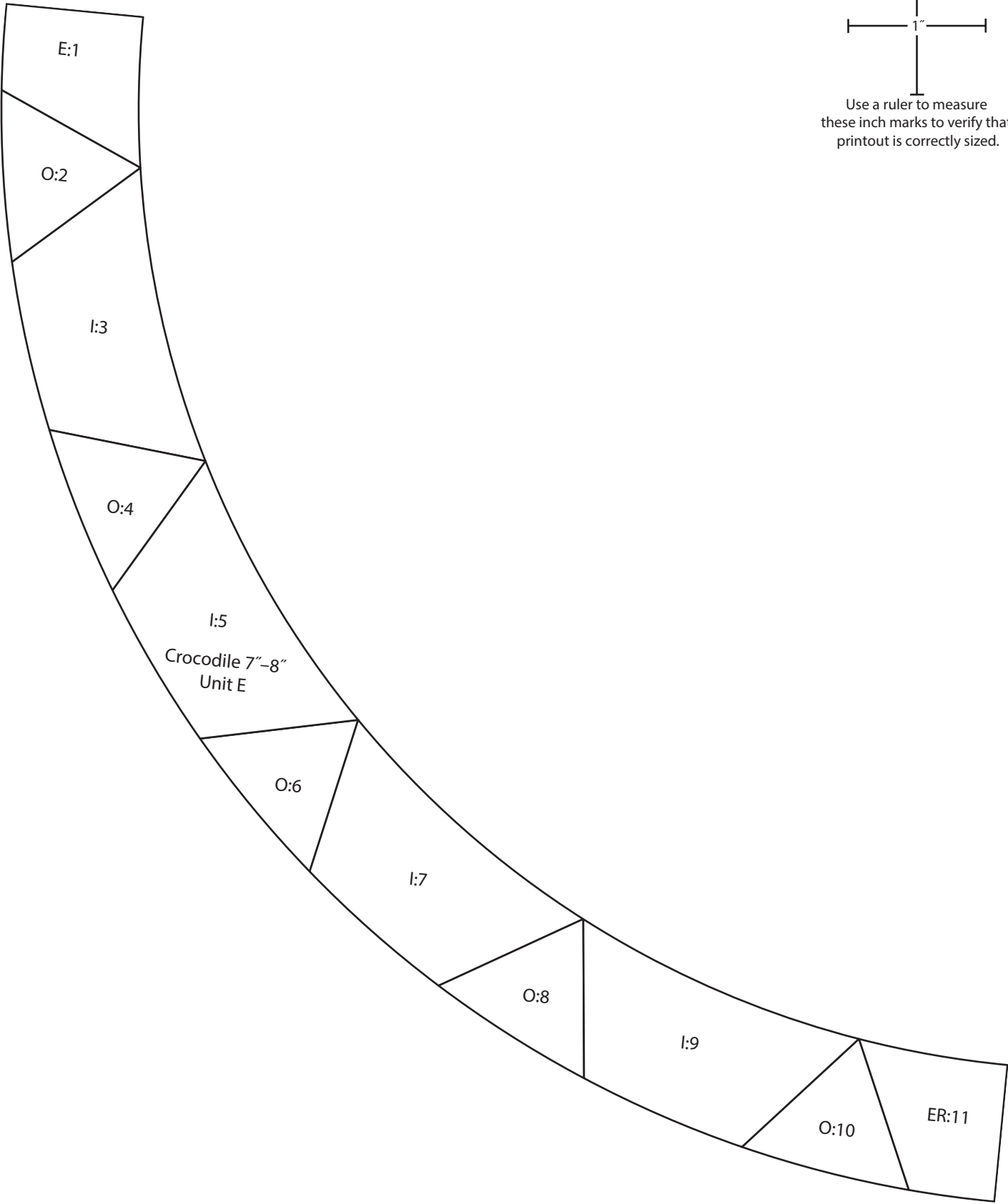

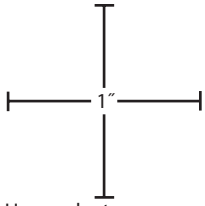

Use a ruler to measure these inch marks to verify that printout is correctly sized.

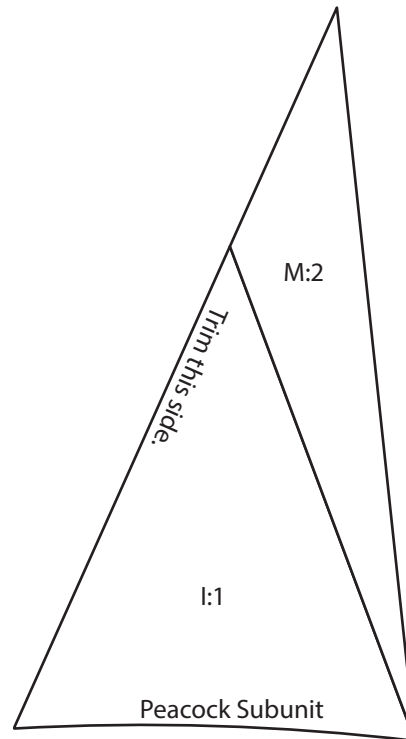
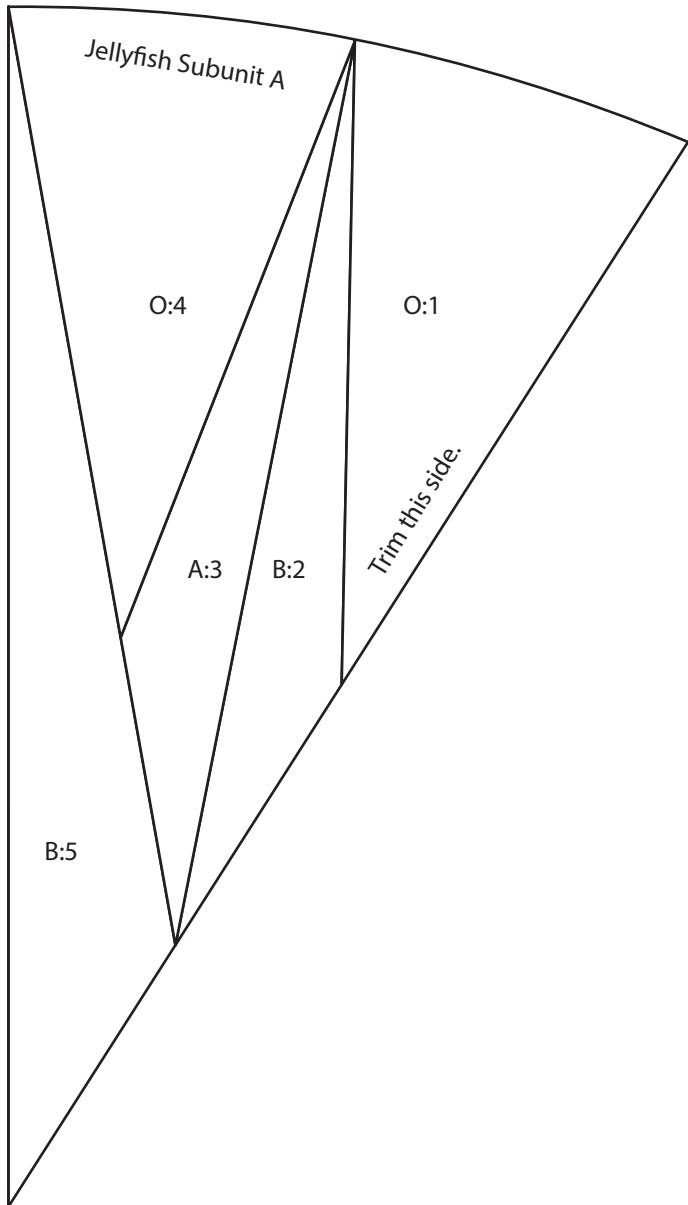
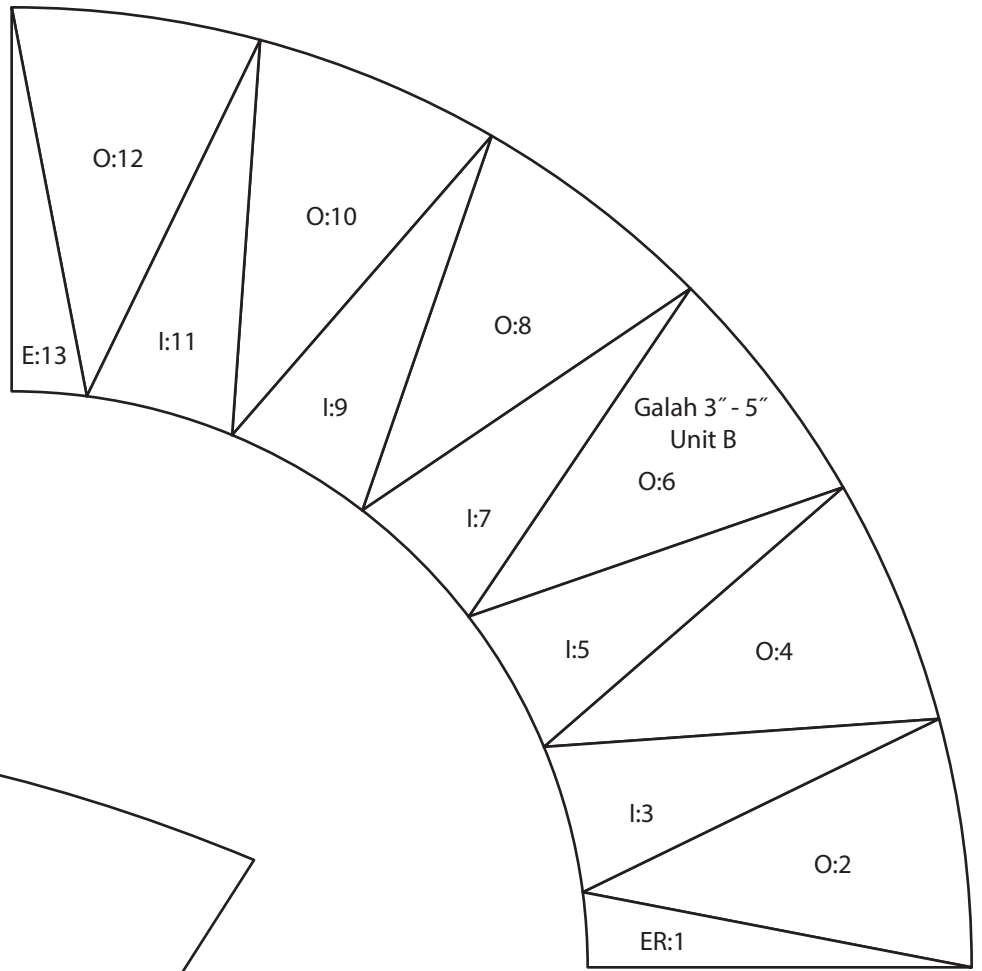

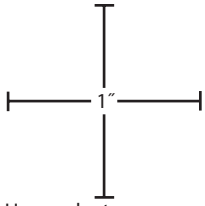

Use a ruler to measure these inch marks to verify that printout is correctly sized.

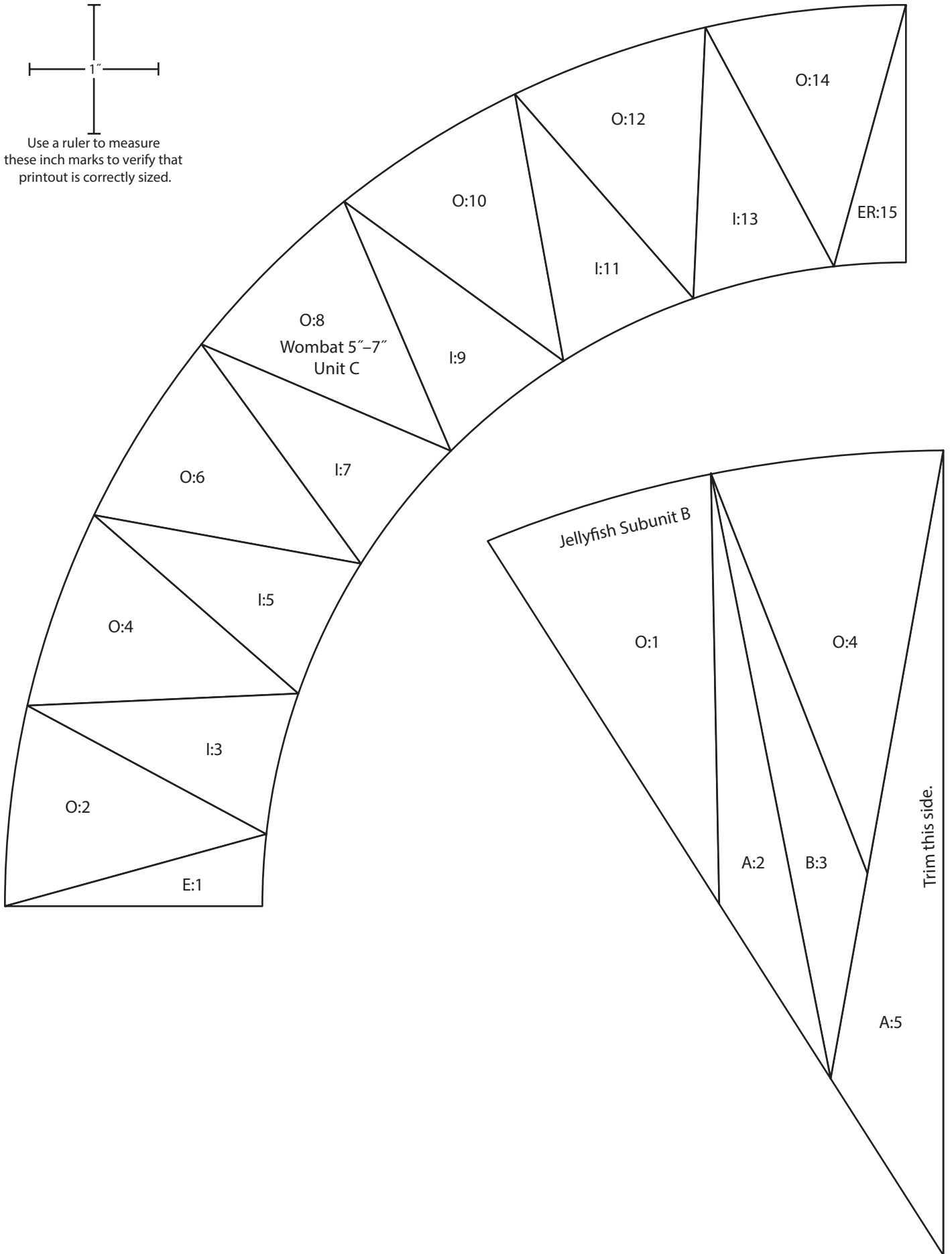

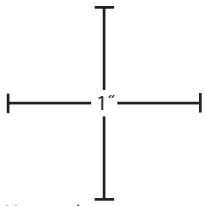

Use a ruler to measure these inch marks to verify that printout is correctly sized.

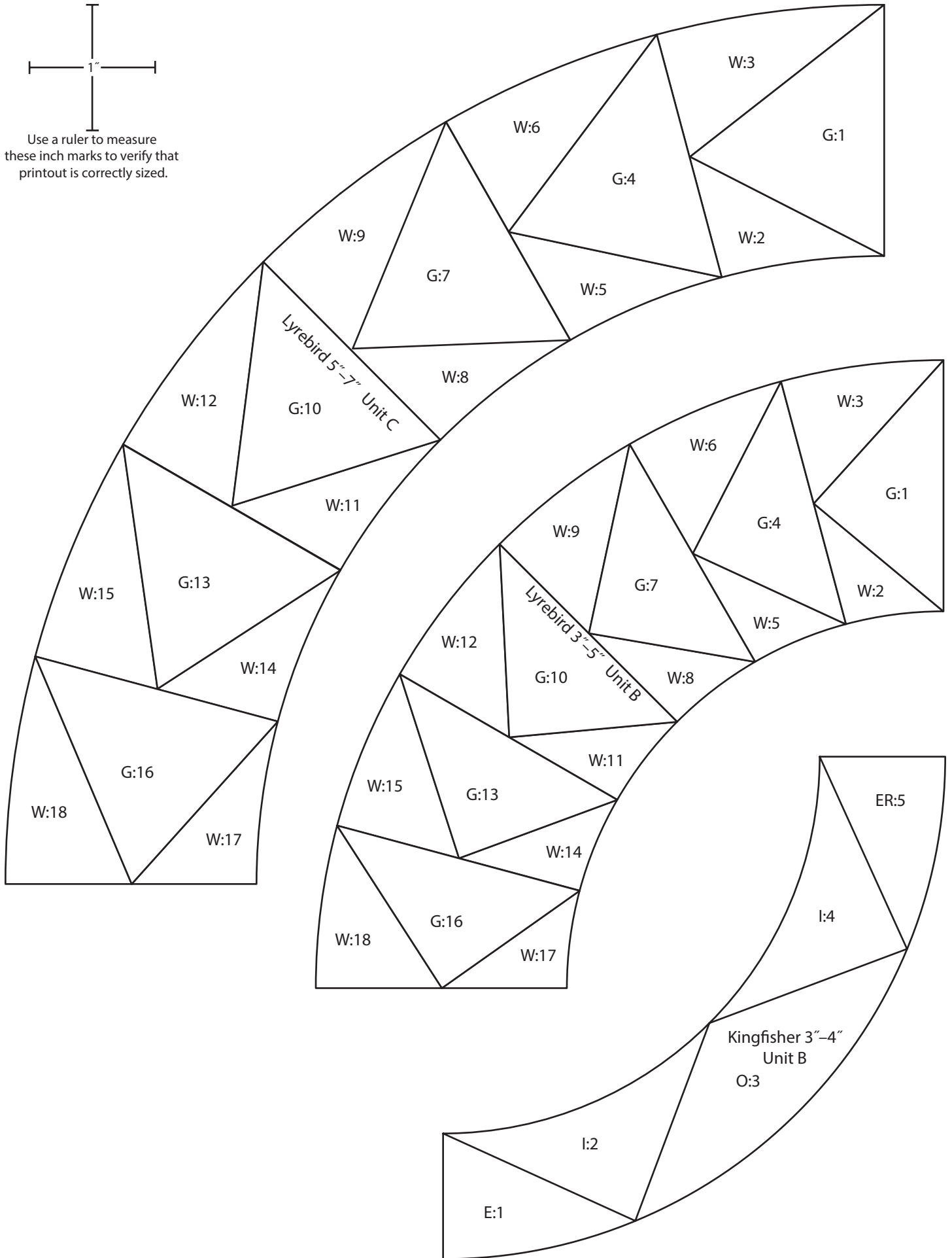

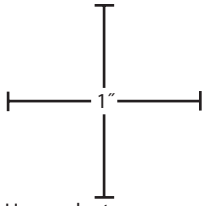

Use a ruler to measure these inch marks to verify that printout is correctly sized.

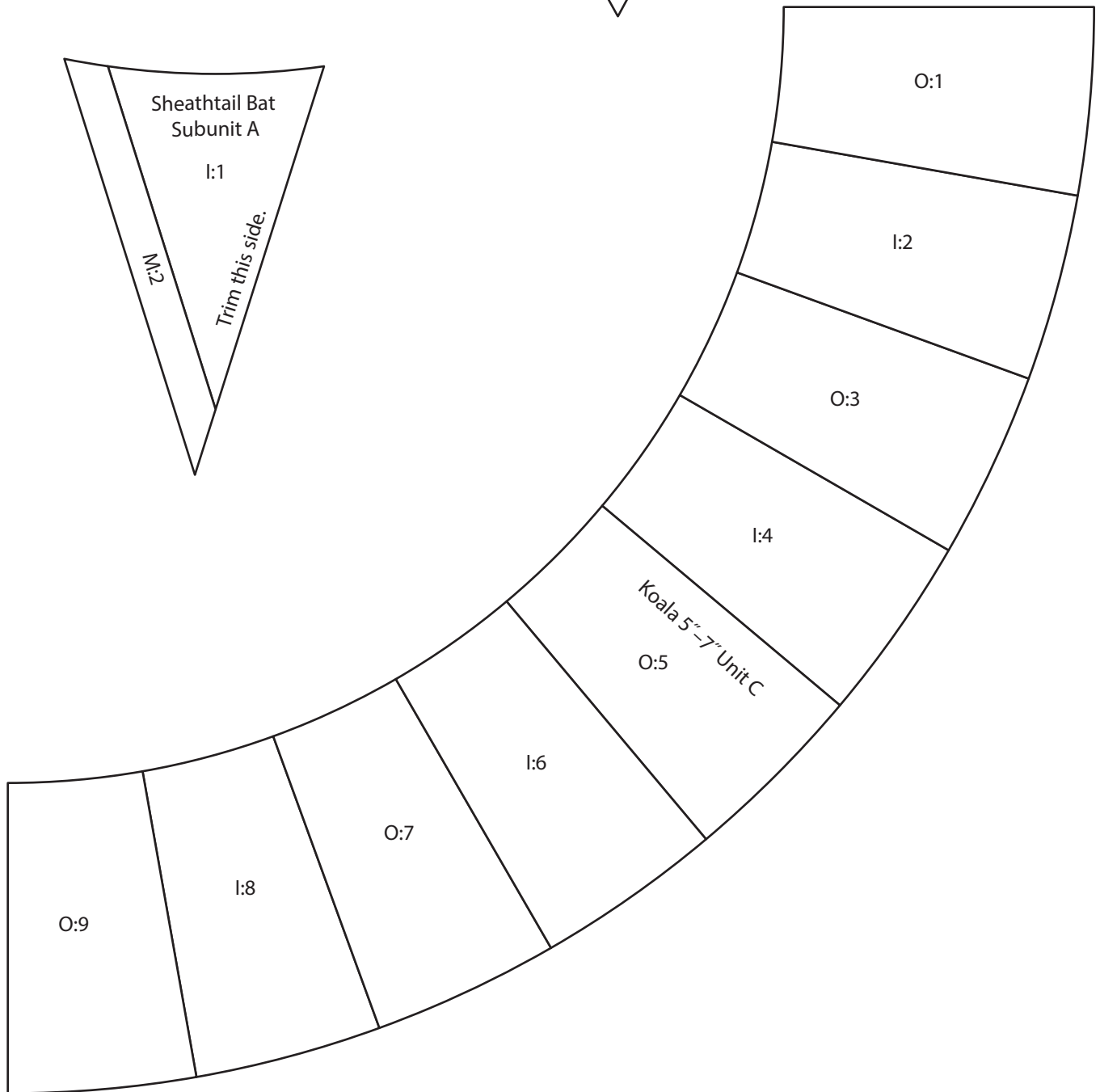
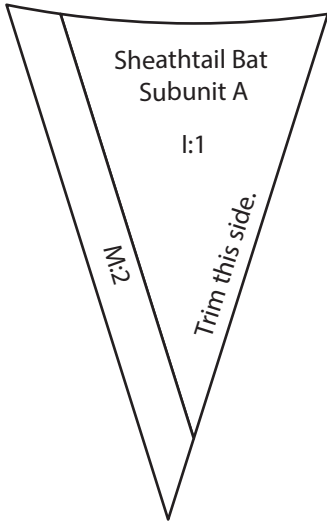
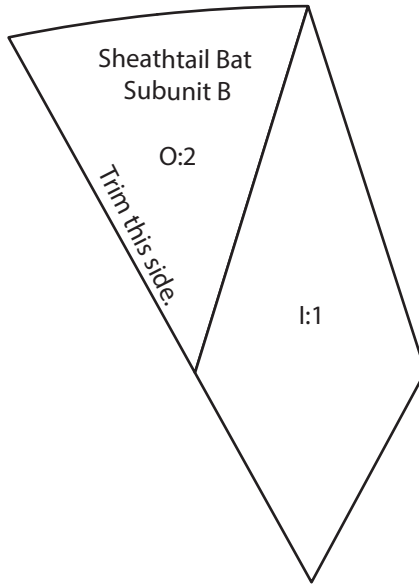

Bluebottle 9¼" - 14½" Unit D

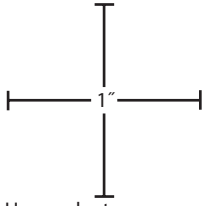

Use a ruler to measure these inch marks to verify that printout is correctly sized.

To make complete pattern, join the following pages, following the diagram for reference.

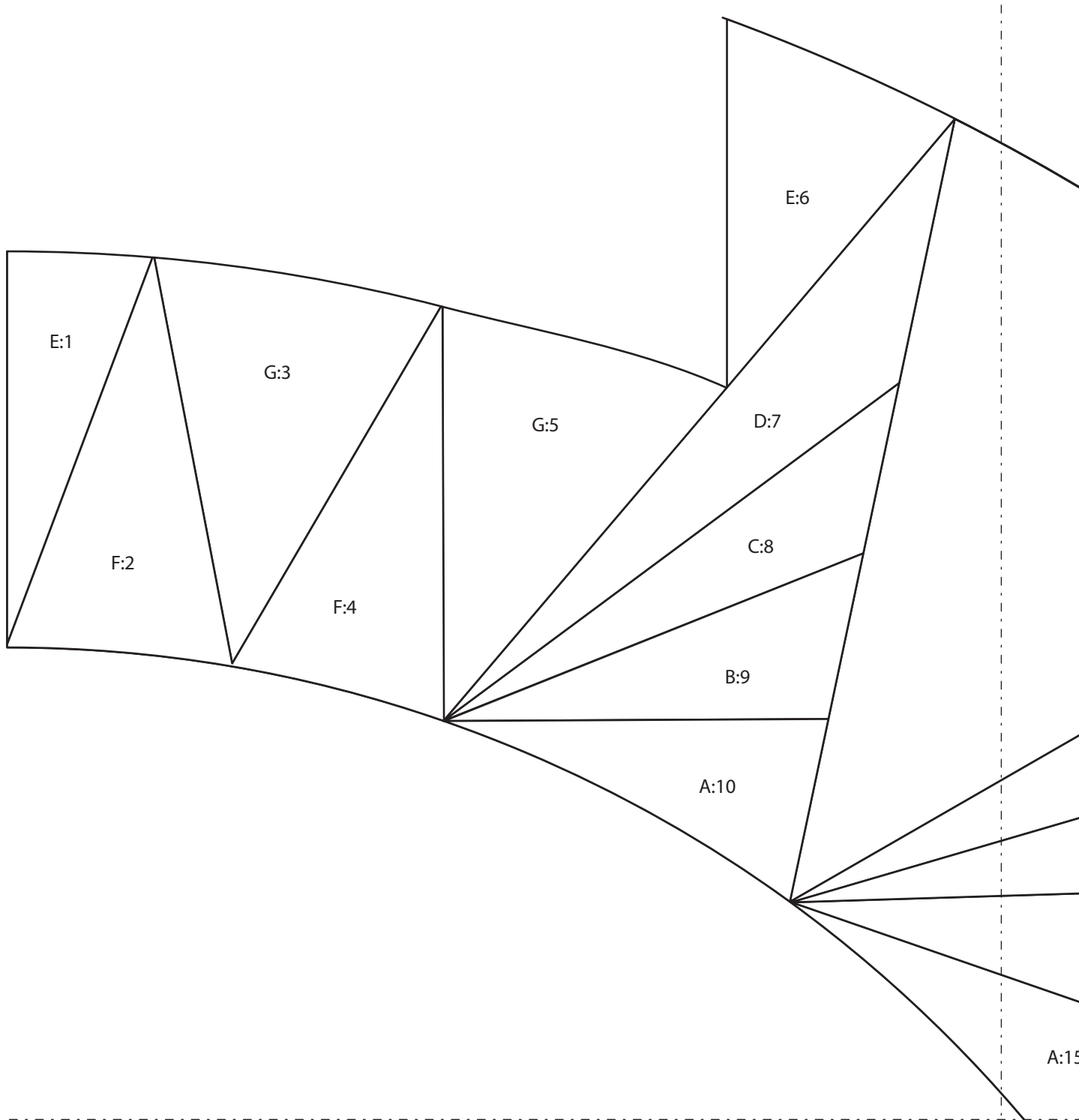
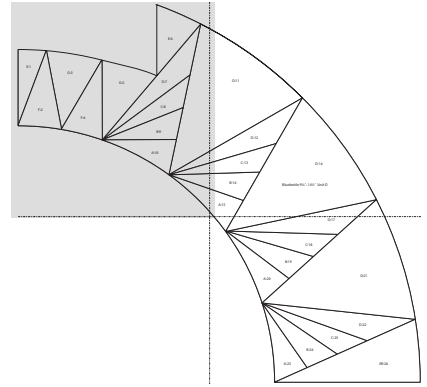

Bluebottle 9¼" - 14½" Unit D

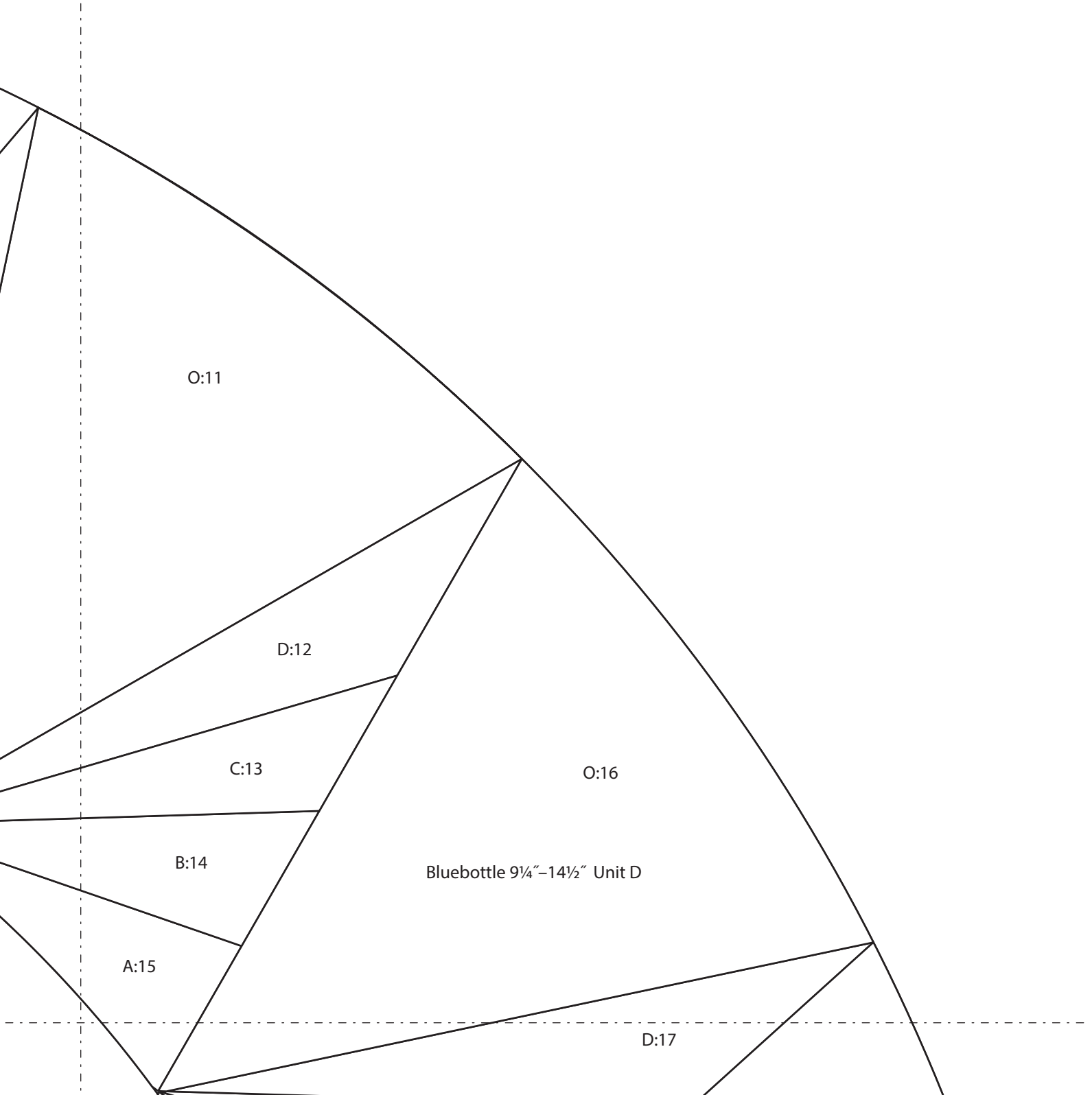
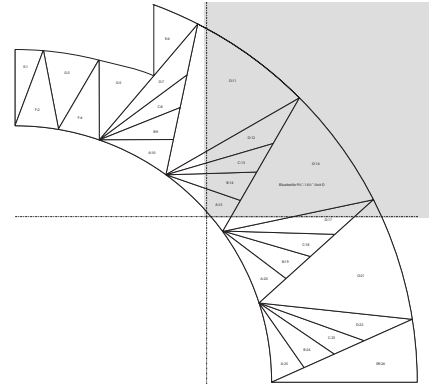
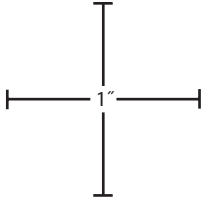

Bluebottle 9¼" - 14½" Unit D

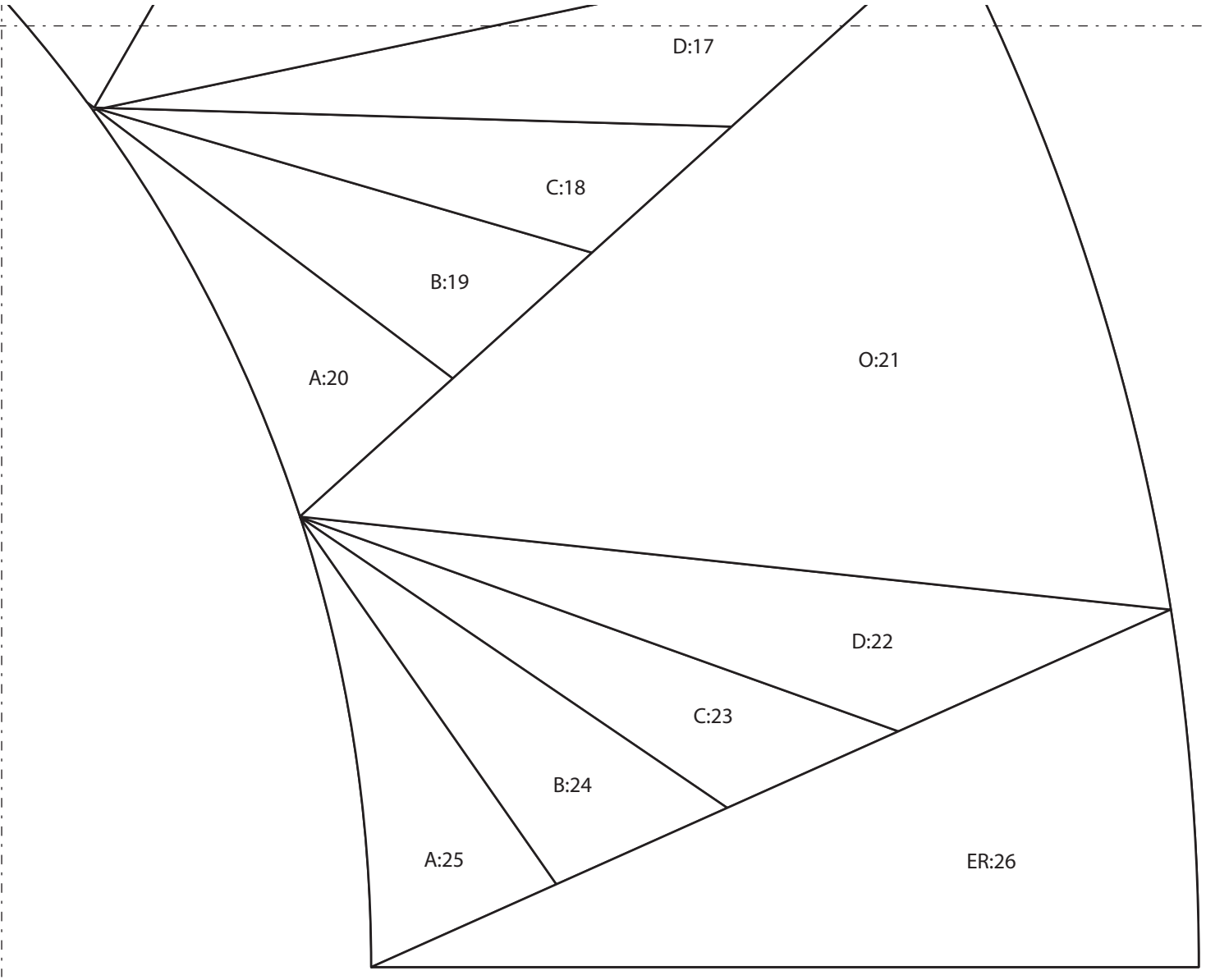
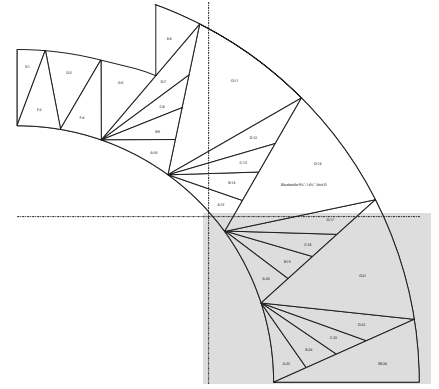
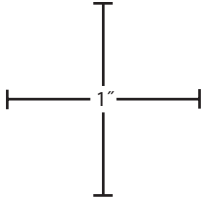

Fruit Bat 5 - 9¼" Unit C

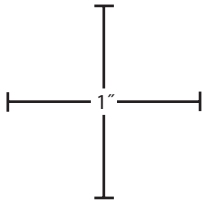
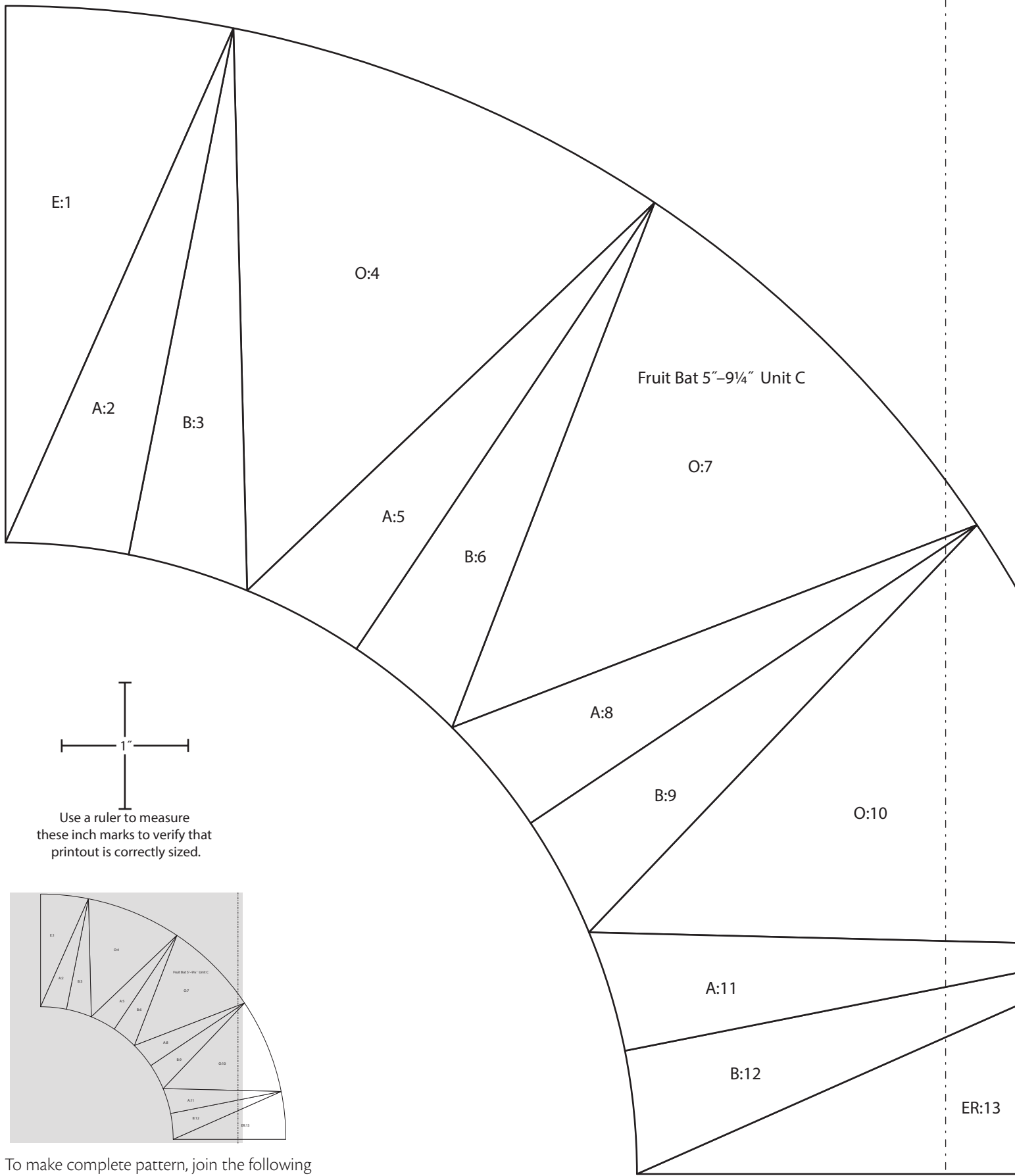

Use a ruler to measure these inch marks to verify that printout is correctly sized.

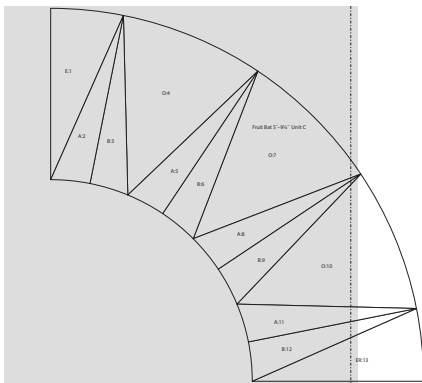

To make complete pattern, join the following pages, following the diagram for reference.

Fruit Bat 5 - 9 1/4" Unit C

