

Errata for
**Double Wedding Ring Quilts -
Tradition Made Modern
#11100**

All of the patterns for Bright Lights, Big City / Retro Poly Mod / Strings of Florid Blooms have been updated to match the templates that the author uses in her classes.

A PDF with the full set of patterns for these quilts is attached.

Bright Lights, Big City
Retro Poly Mod
Strings of Florid Blooms

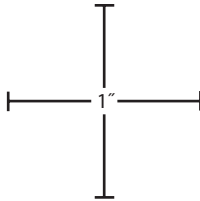

Use a ruler to measure these inch marks to verify that printout is correctly sized.

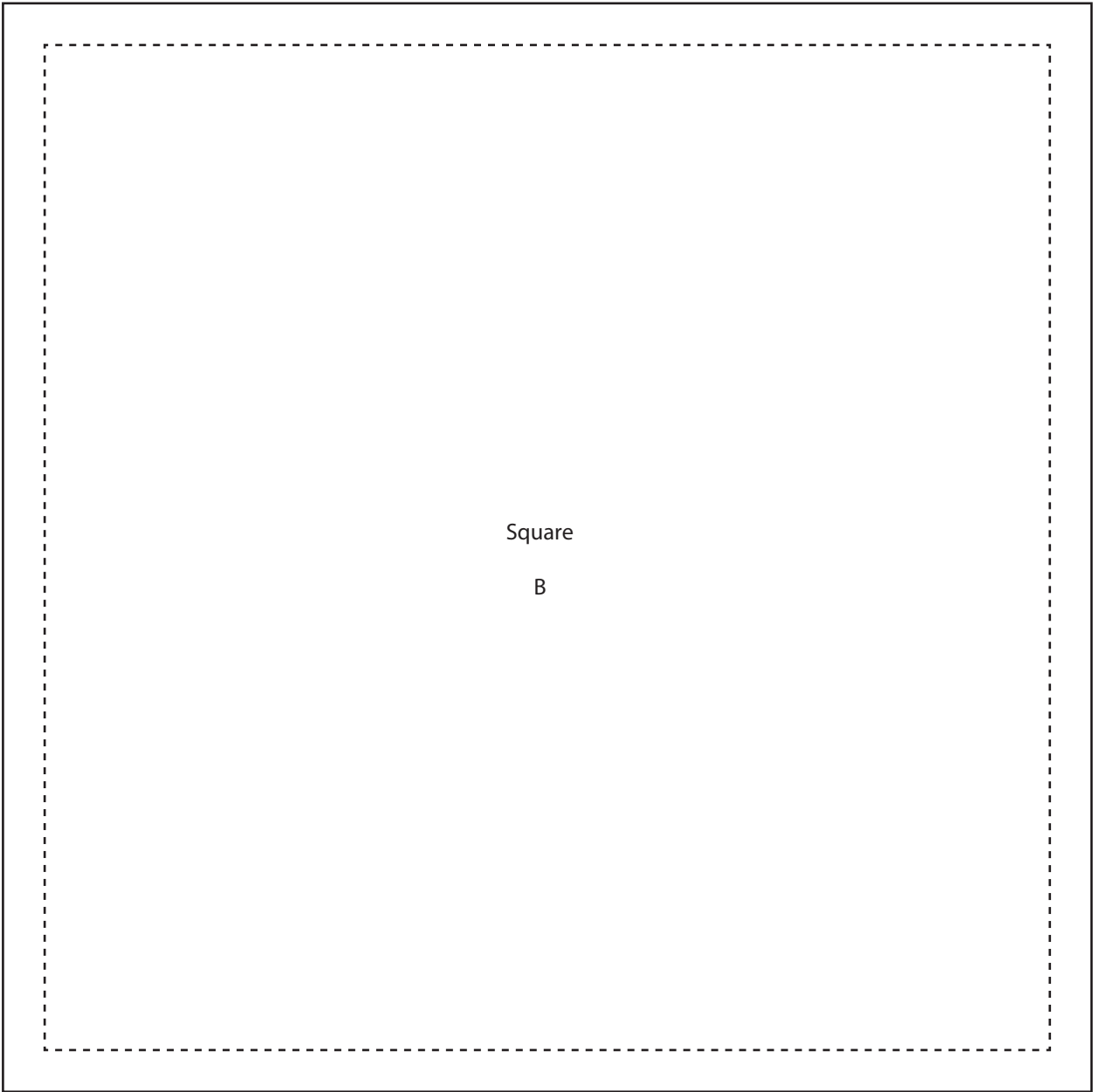

Bright Lights, Big City
Retro Poly Mod
Strings of Florid Blooms

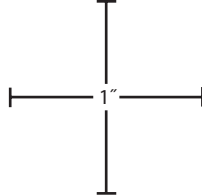

Use a ruler to measure these inch marks to verify that printout is correctly sized.

To make complete pattern, join the following pages, following the diagram for reference.

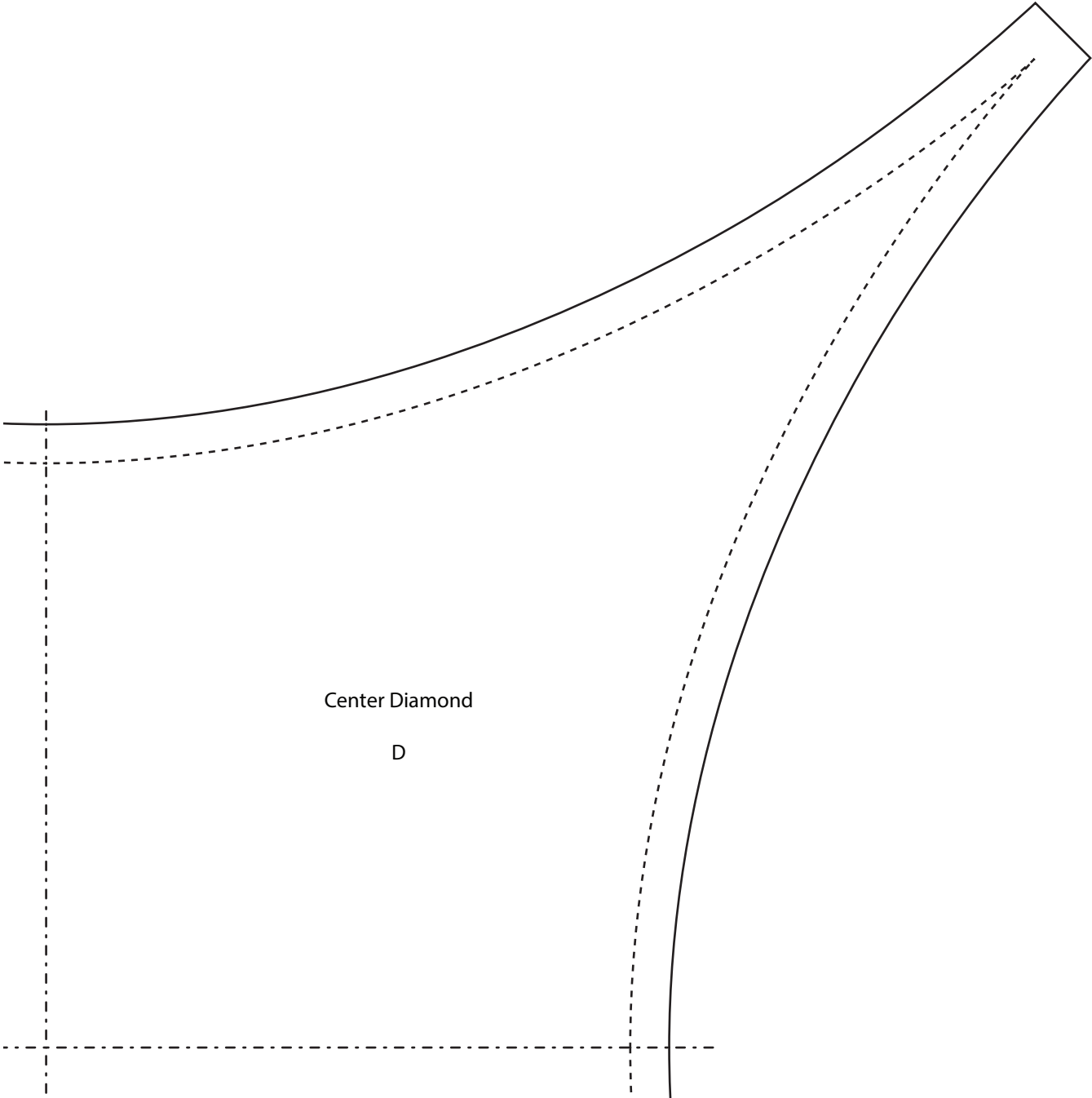
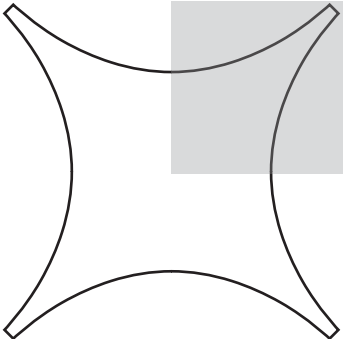

Center Diamond

D

Bright Lights, Big City
Retro Poly Mod
Strings of Florid Blooms

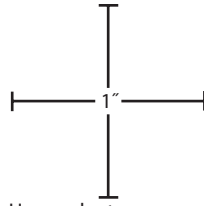

Use a ruler to measure these inch marks to verify that printout is correctly sized.

To make complete pattern, join the following pages, following the diagram for reference.

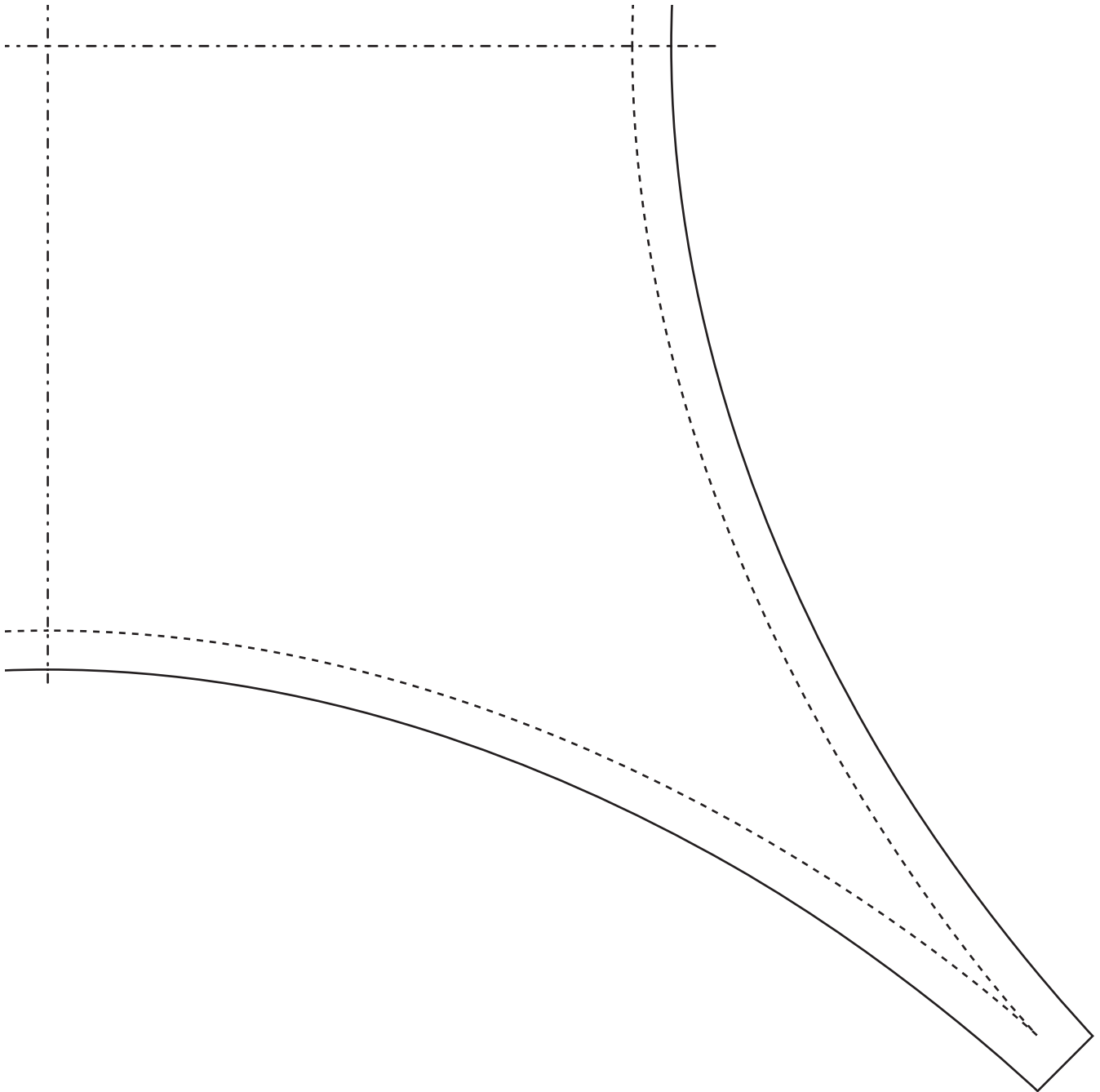
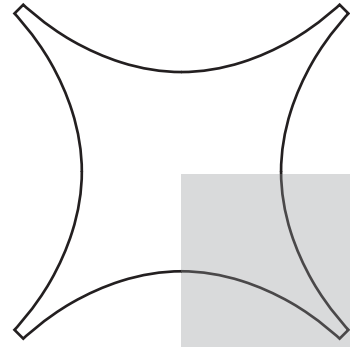

Bright Lights, Big City
Retro Poly Mod
Strings of Florid Blooms

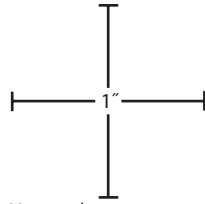

Use a ruler to measure these inch marks to verify that printout is correctly sized.

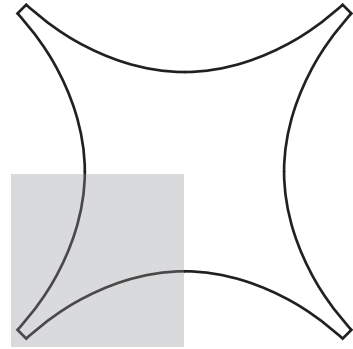

To make complete pattern, join the following pages, following the diagram for reference.

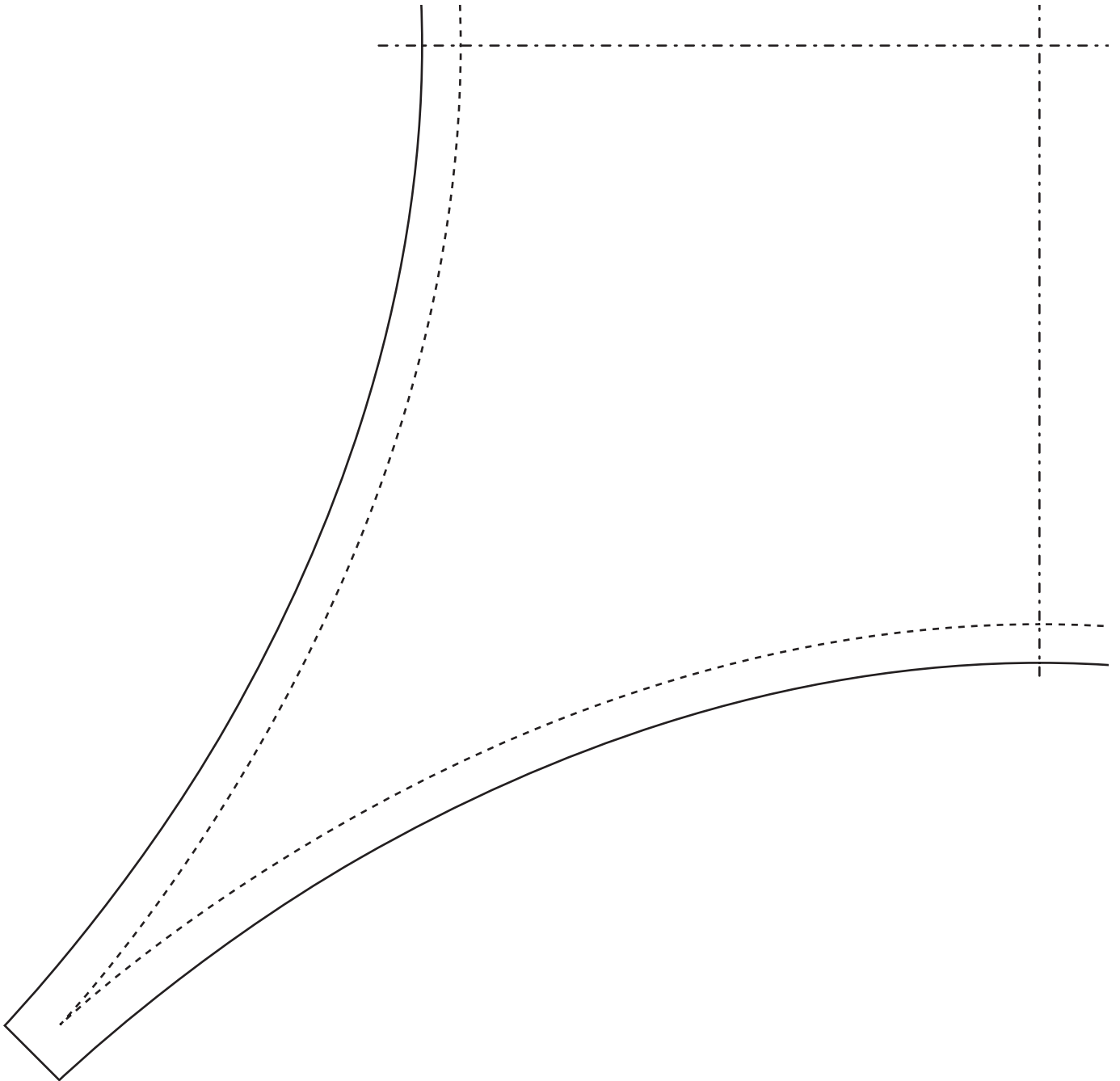

Bright Lights, Big City
Retro Poly Mod
Strings of Florid Blooms

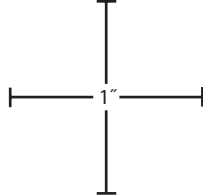

Use a ruler to measure these inch marks to verify that printout is correctly sized.

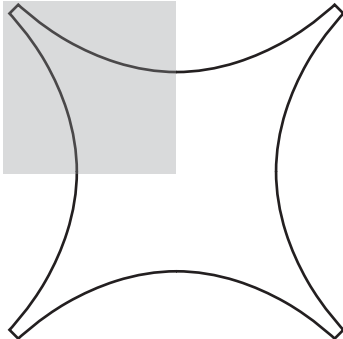

To make complete pattern, join the following pages, following the diagram for reference.

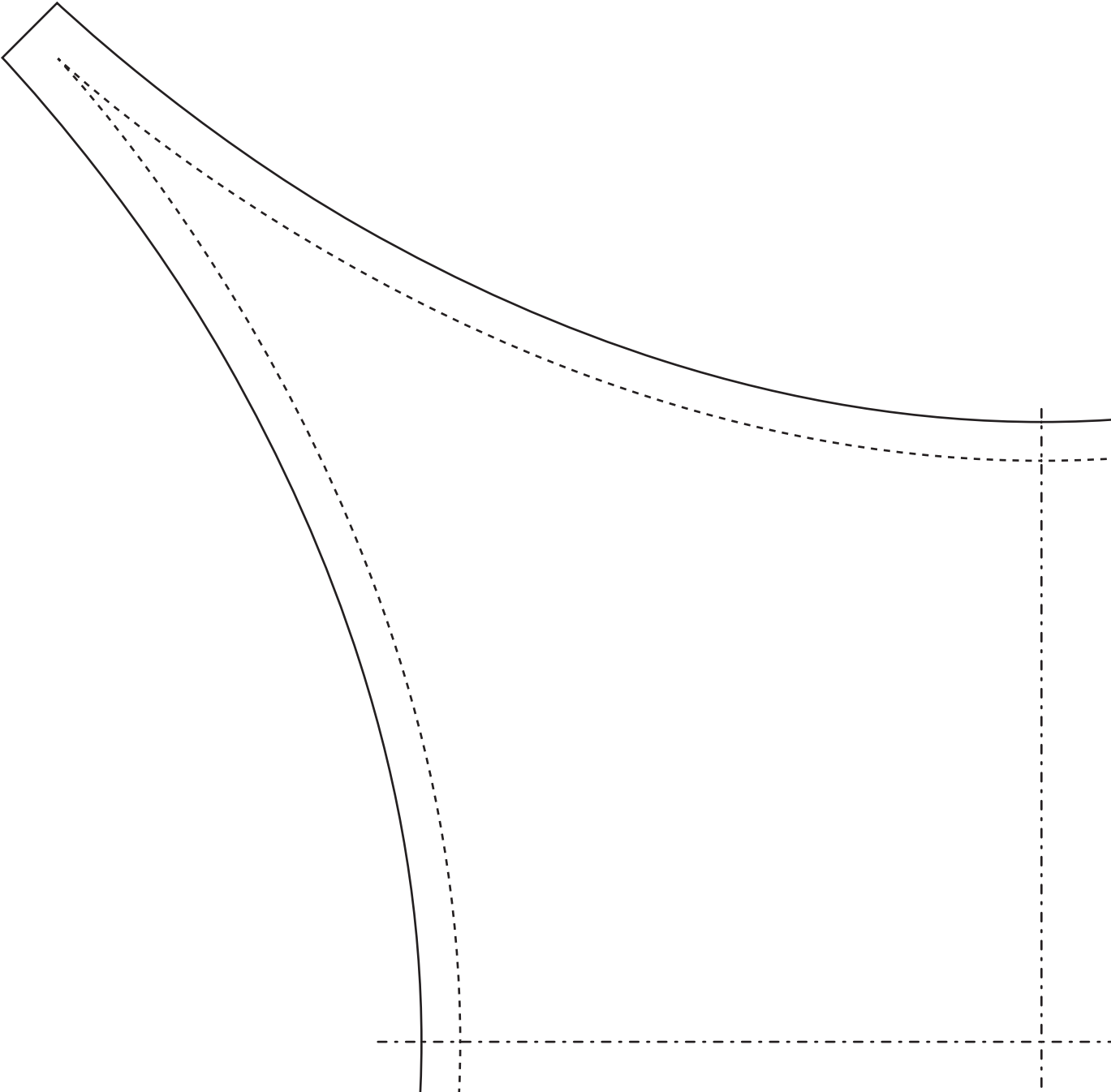

Bright Lights, Big City
Retro Poly Mod
Strings of Florid Blooms

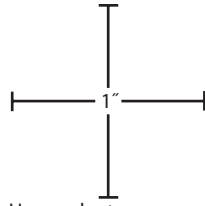

Use a ruler to measure these inch marks to verify that printout is correctly sized.

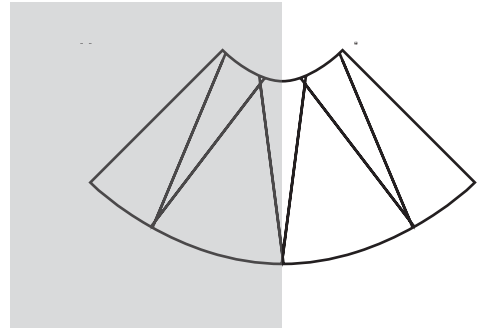

To make complete pattern, join the following pages, following the diagram for reference.

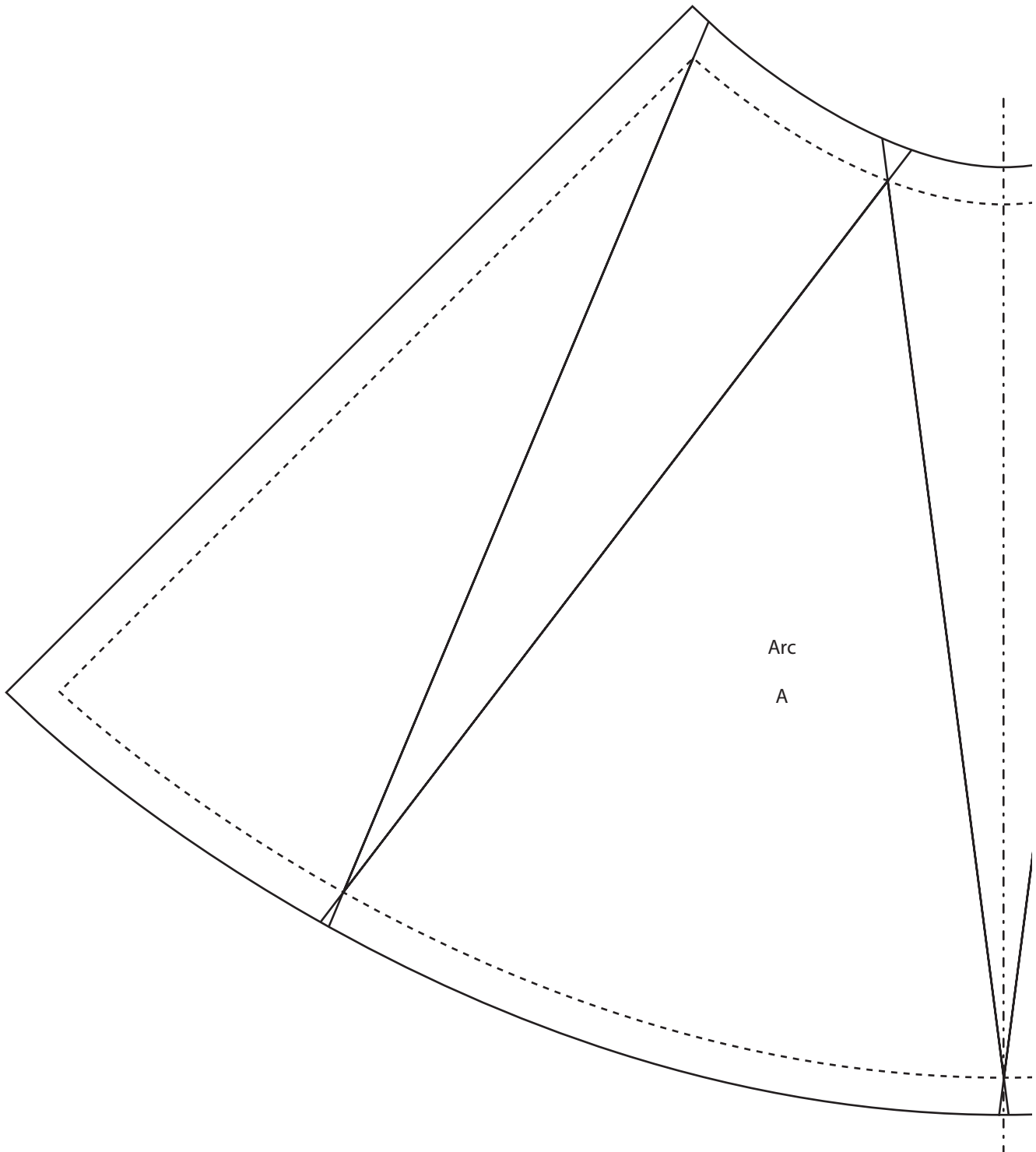

Bright Lights, Big City
Retro Poly Mod
Strings of Florid Blooms

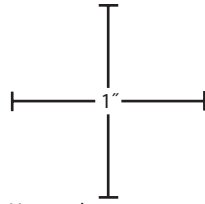

Use a ruler to measure these inch marks to verify that printout is correctly sized.

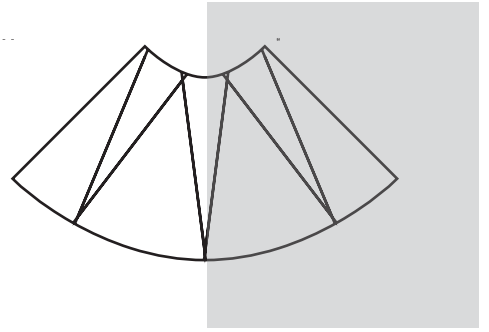

To make complete pattern, join the following pages, following the diagram for reference.

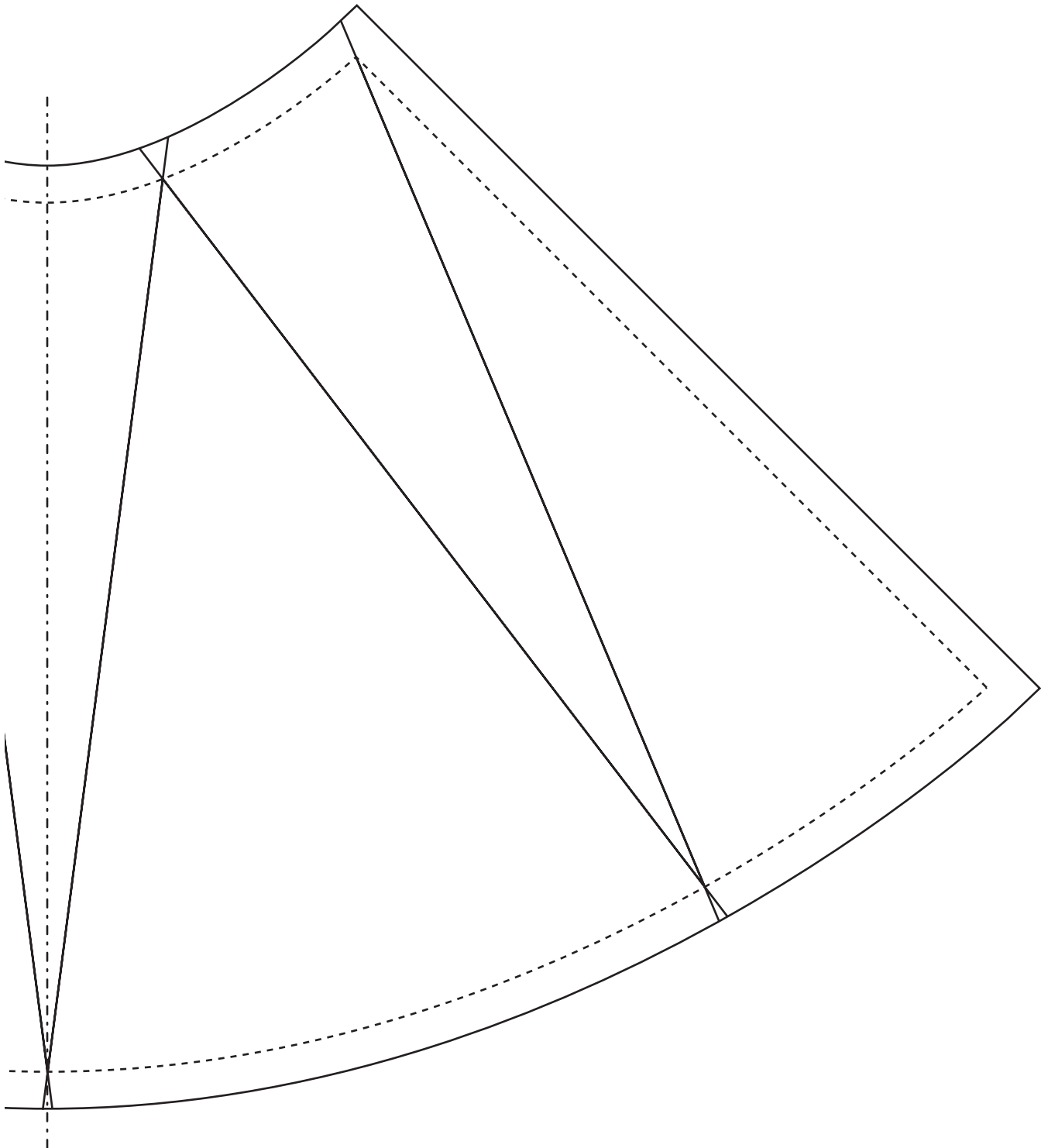

Bright Lights, Big City
Retro Poly Mod
Strings of Florid Blooms

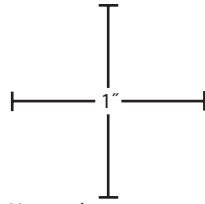

Use a ruler to measure these inch marks to verify that printout is correctly sized.

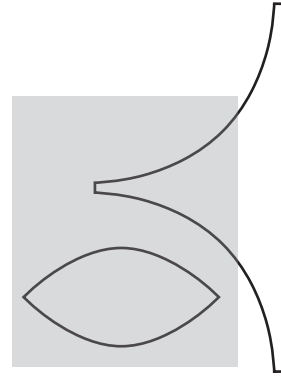

To make complete pattern, join the following pages, following the diagram for reference.

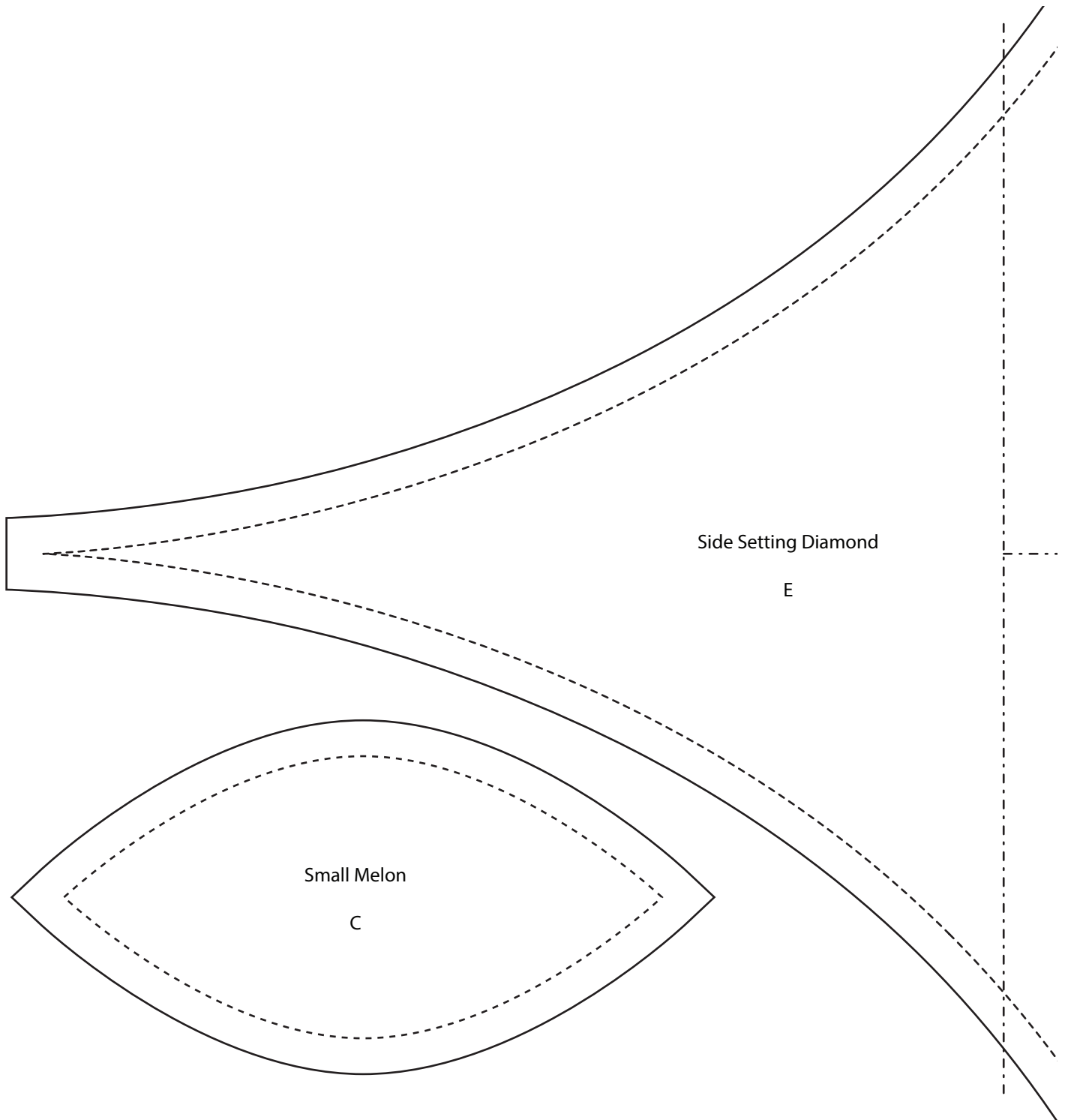

Bright Lights, Big City
Retro Poly Mod
Strings of Florid Blooms

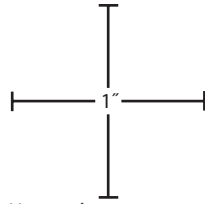

Use a ruler to measure these inch marks to verify that printout is correctly sized.

To make complete pattern, join the following pages, following the diagram for reference.

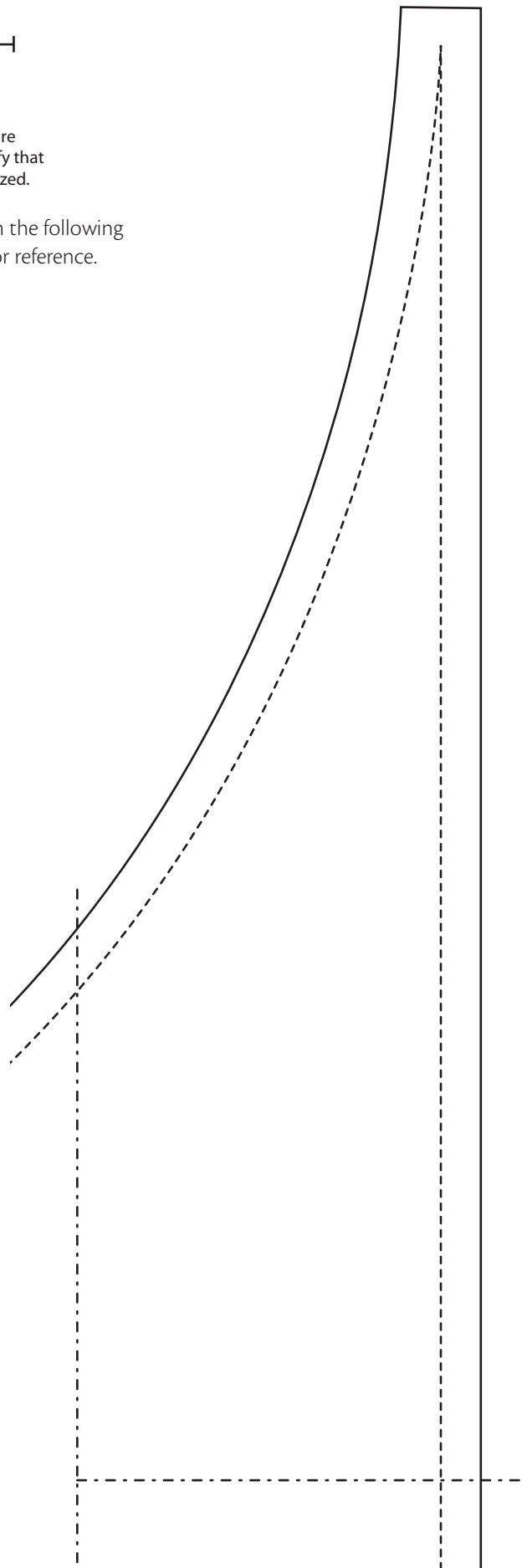
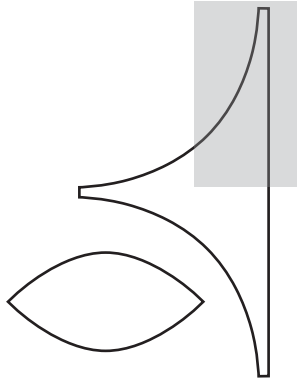

Bright Lights, Big City
Retro Poly Mod
Strings of Florid Blooms

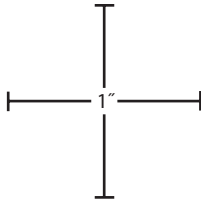

Use a ruler to measure these inch marks to verify that printout is correctly sized.

To make complete pattern, join the following pages, following the diagram for reference.

